



### DESCRIPTION:

The JR0205N2 SCR with the parallel resistor between Gate and Cathode,  $R_{GK}=10\sim 80k\Omega$ , is especially recommended for use on straight hair, igniter, anion generator, etc. Package SOT-89-2L is RoHS compliant.

### MAIN FEATURES

Symbol	Value	Unit
$I_{T(RMS)}$	2	A
$V_{DRM}/V_{RRM}$	600	V
$I_{GT}$	$\leq 200$	$\mu A$

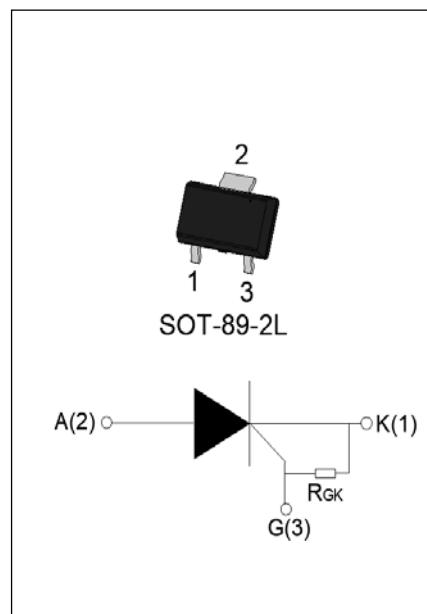

### ABSOLUTE MAXIMUM RATINGS

Parameter	Symbol	Value	Unit
Storage junction temperature range	$T_{stg}$	-40-150	$^{\circ}C$
Operating junction temperature range	$T_j$	-40-125 <sup>①</sup>	$^{\circ}C$
Repetitive peak off-state voltage ( $T_j=25^{\circ}C$ )	$V_{DRM}$	600	V
Repetitive peak reverse voltage ( $T_j=25^{\circ}C$ )	$V_{RRM}$	600	V
Average on-state current ( $T_c \leq 58^{\circ}C$ )	$I_{T(AV)}$	1.3	A
RMS on-state current ( $T_c \leq 58^{\circ}C$ )	$I_{T(RMS)}$	2	A
Non repetitive surge peak on-state current ( $t_p=10ms, T_j=25^{\circ}C$ )	$I_{TSM}$	20	A
Non repetitive surge peak on-state current ( $t_p=8.3ms, T_j=25^{\circ}C$ )		22	
$I^2t$ value for fusing ( $t_p=10ms, T_j=25^{\circ}C$ )	$I^2t$	2	$A^2s$
Critical rate of rise of on-state current ( $I_G=2 \times I_{GT}, f=100Hz, T_j=125^{\circ}C$ )	$di/dt$	50	$A/\mu s$
Peak gate current ( $t_p=20\mu s, T_j=125^{\circ}C$ )	$I_{GM}$	1.2	A
Average gate power dissipation ( $T_j=125^{\circ}C$ )	$P_{G(AV)}$	0.2	W

Peak gate power	$P_{GM}$	2	W
Peak pulse voltage ( $T_j=25^{\circ}\text{C}$ ; non-repetitive, off-state; FIG.8)	$V_{pp}$	0.5	kV

**NOTE 1:** When we parallel connect a  $\leq 1\text{K}\Omega$  resistor between Gate and Cathode, the  $T_j$  can reach  $125^{\circ}\text{C}$ ; if without this resistor, the  $T_j$  only can reach  $110^{\circ}\text{C}$ .

### ELECTRICAL CHARACTERISTICS ( $T_j=25^{\circ}\text{C}$ unless otherwise specified)

Symbol	Test Condition	Value			Unit
		MIN.	TYP.	MAX.	
$I_{GT}$	$V_D=12\text{V } R_L=33\Omega$	-	40	200	$\mu\text{A}$
$V_{GT}$		-	0.5	0.8	V
$V_{GD}$	$V_D=V_{DRM } T_j=125^{\circ}\text{C}$	0.2	-	-	V
$I_L$	$I_G=1.2 I_{GT}$	-	-	3	mA
$I_H$	$I_T=0.1\text{A}$	-	-	2	mA
dV/dt	$V_D=400\text{V } T_j=125^{\circ}\text{C } R_{GK}=1\text{K}\Omega$	50	-	-	$\text{V}/\mu\text{s}$
	$V_D=400\text{V } T_j=125^{\circ}\text{C } R_{GK}=220\Omega$	250	-	-	
$t_{on}$	$I_G=10\text{mA } I_A=20\text{mA } I_R=2\text{mA}$ $T_j=25^{\circ}\text{C}$	-	2	-	$\mu\text{s}$
$t_{off}$		-	50	-	

### STATIC CHARACTERISTICS

Symbol	Parameter		Value(MAX.)	Unit
$V_{TM}$	$I_{TM}=4\text{A } t_p=380\mu\text{s}$	$T_j=25^{\circ}\text{C}$	1.5	V
$V_{TO}$	Threshold voltage	$T_j=125^{\circ}\text{C}$	0.73	V
$R_D$	Dynamic resistance	$T_j=125^{\circ}\text{C}$	0.14	$\Omega$
$I_{DRM}$	$V_D=V_{DRM } V_R=V_{RRM}$	$T_j=25^{\circ}\text{C}$	5	$\mu\text{A}$
$I_{RRM}$		$T_j=125^{\circ}\text{C}$	0.2	mA

### THERMAL RESISTANCES

Symbol	Parameter	Value	Unit
$R_{th(j-c)}$	junction to case (DC)	25	$^{\circ}\text{C}/\text{W}$
$R_{th(j-a)}$	junction to ambient (DC, in free air, $S=5\text{cm}^2$ )	100	$^{\circ}\text{C}/\text{W}$

ORDERING INFORMATION

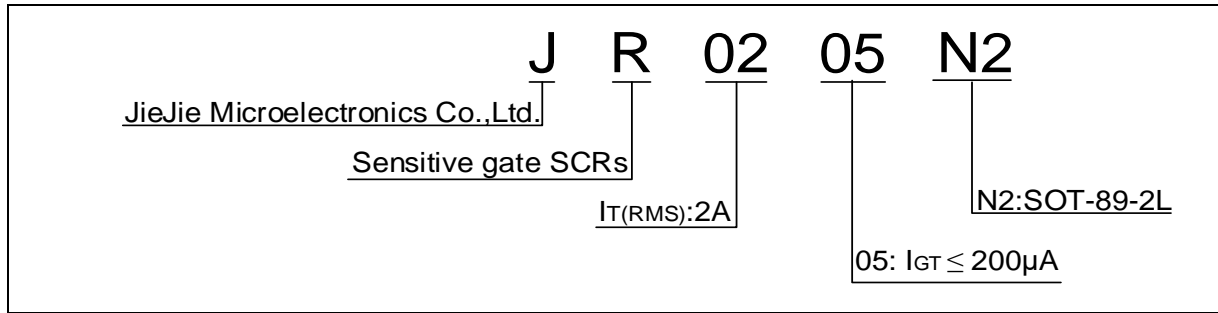

MARKING

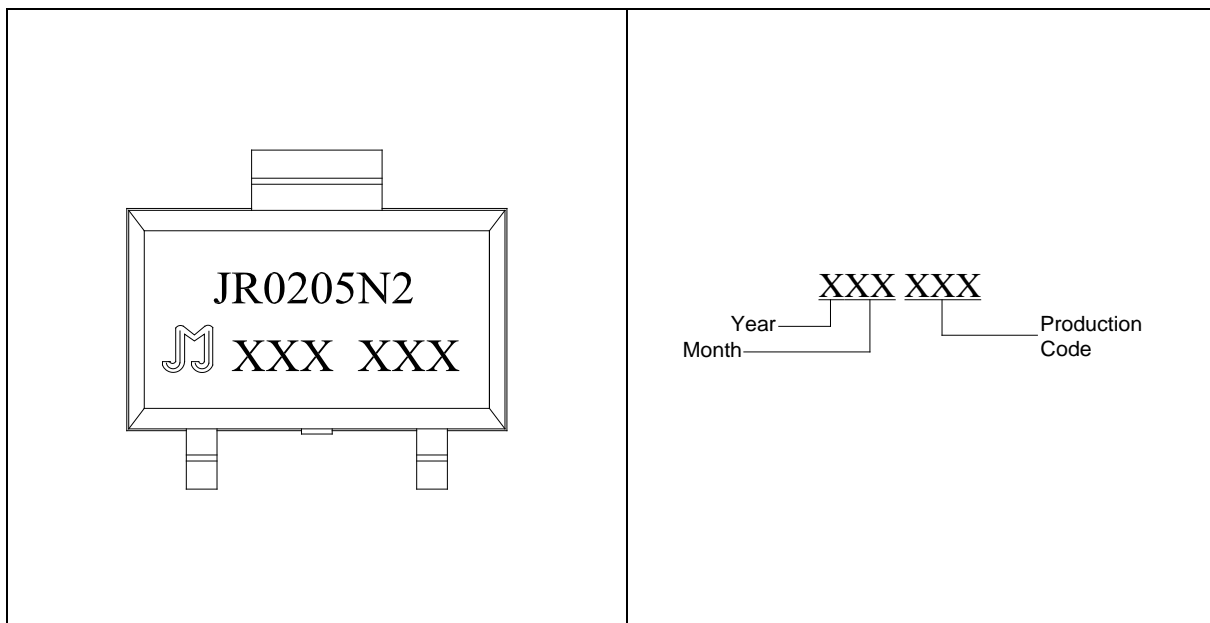

**FIG.1** Maximum power dissipation versus RMS on-state current

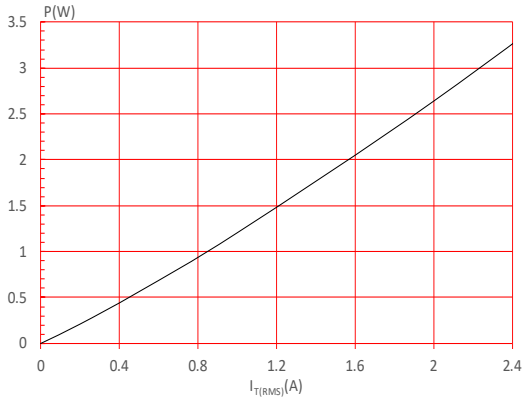

**FIG.2:** RMS on-state current versus case temperature

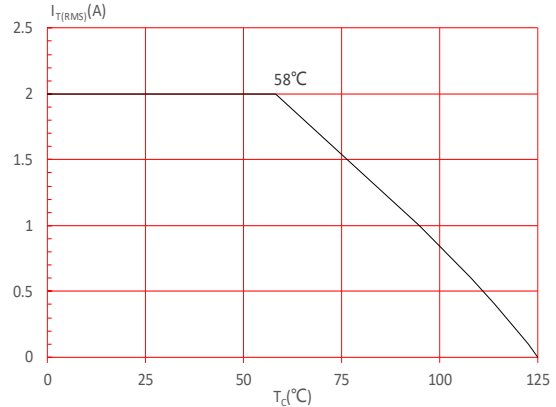

**FIG.3:** RMS on-state current versus ambient temperature (printed circuit board FR4,copper thickness:35μm)(full cycle)

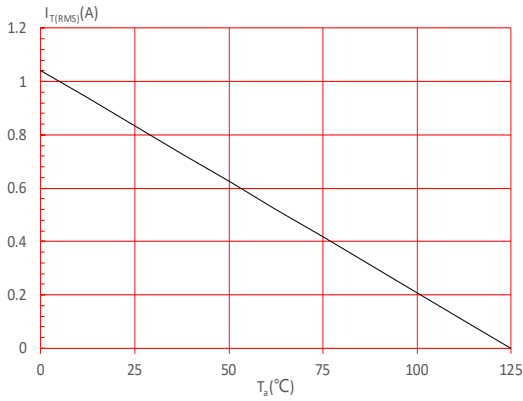

**FIG.4:** Surge peak on-state current versus number of cycles

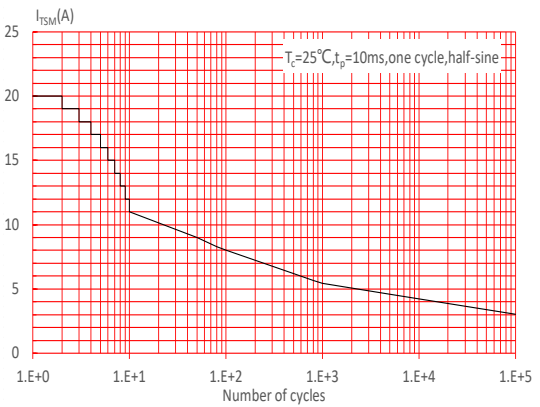

**FIG.5:** On-state characteristics

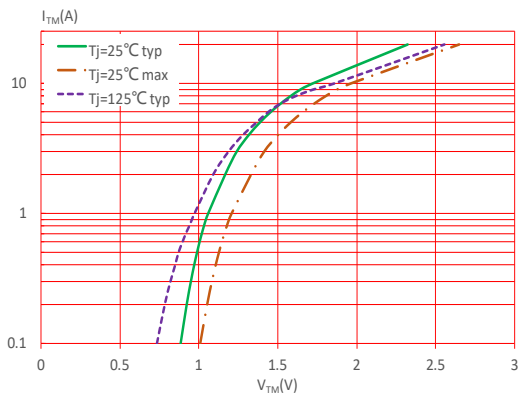

**FIG.6:** Non-repetitive surge peak on-state current for a sinusoidal pulse with width  $t_p < 10\text{ms}$ , and corresponding value of  $I^2t$  ( $di/dt < 50\text{A}/\mu\text{s}$ )

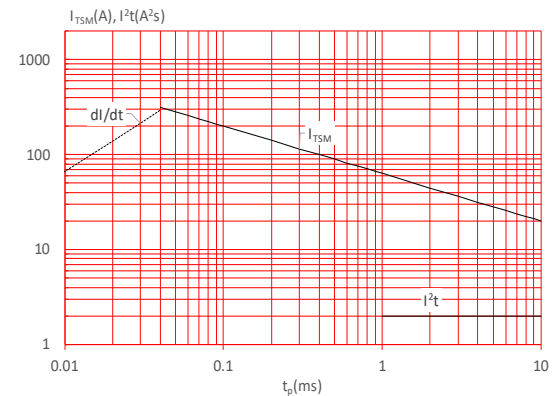

FIG.7: Relative variations of gate trigger current, holding current and latching current versus junction temperature

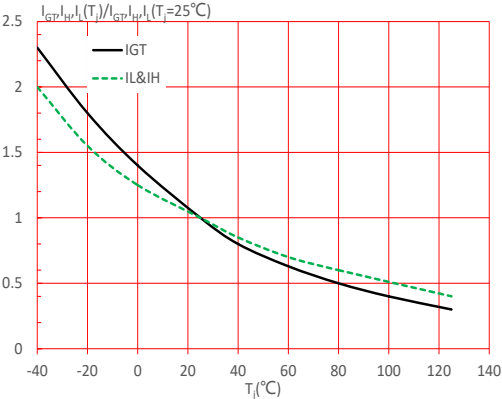
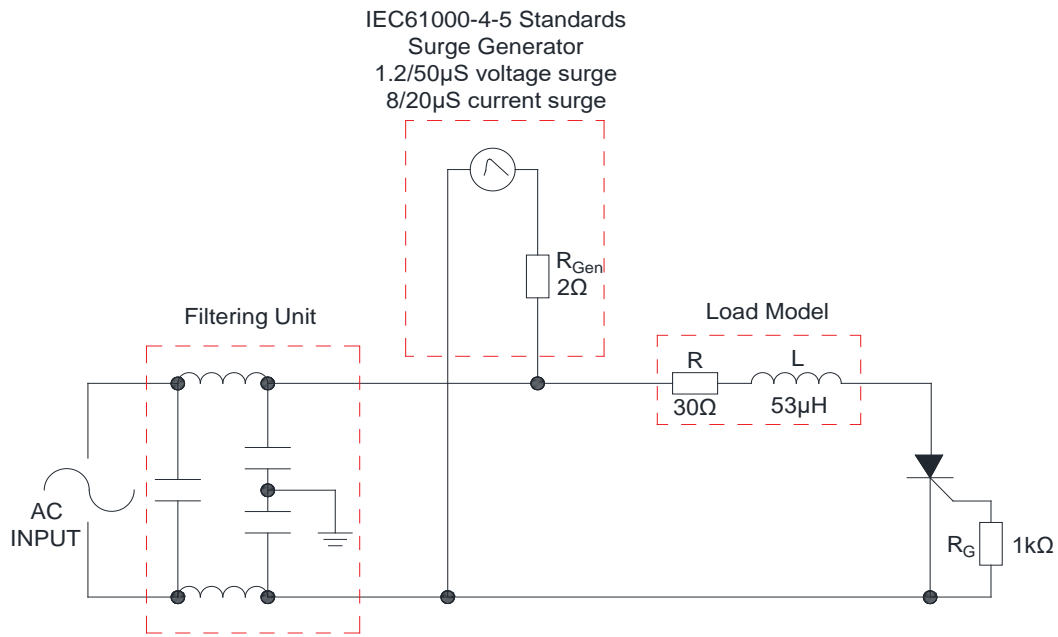
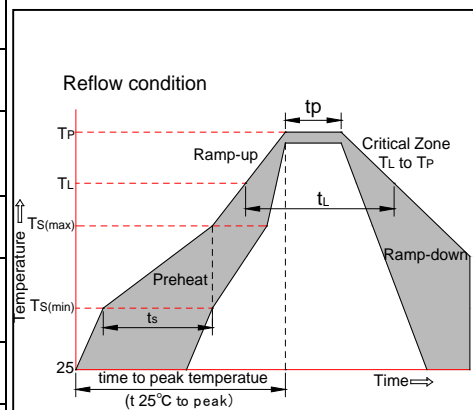

FIG.8: Test circuit for inductive and resistive loads to IEC-61000-4-5 standards



**SOLDERING PARAMETERS**

Reflow Condition		Pb-Free assembly (see figure at right)
Pre Heat	-Temperature Min ( $T_{s(min)}$ )	+150°C
	-Temperature Max( $T_{s(max)}$ )	+200°C
	-Time (Min to Max) ( $t_s$ )	60-180 secs.
Average ramp up rate (Liquidus Temp ( $T_L$ ) to peak)		3°C/sec. Max
$T_{s(max)}$ to $T_L$ - Ramp-up Rate		3°C/sec. Max
Reflow	-Temperature( $T_L$ ) (Liquidus)	+217°C
	-Temperature( $t_L$ )	60-150 secs.
Peak Temp ( $T_p$ )		+260(+0/-5)°C
Time within 5°C of actual Peak Temp ( $t_p$ )		20-40secs.
Ramp-down Rate		6°C/sec. Max
Time 25°C to Peak Temp ( $T_P$ )		8 min. Max
Do not exceed		+260°C



**ORDERING INFORMATION**

Order code	Voltage $V_{DRM}/V_{RRM}$ (V)	IGT( $\mu$ A)	Package	Base qty. (pcs)	Delivery mode
JR0205N2	600	$\leq 200$	SOT-89-2L	4,000	Tape & Reel

**Document Revision History**

Date	Revision	Changes
Apr.10, 2023	A.1.0	Last update

**PACKAGE MECHANICAL DATA**

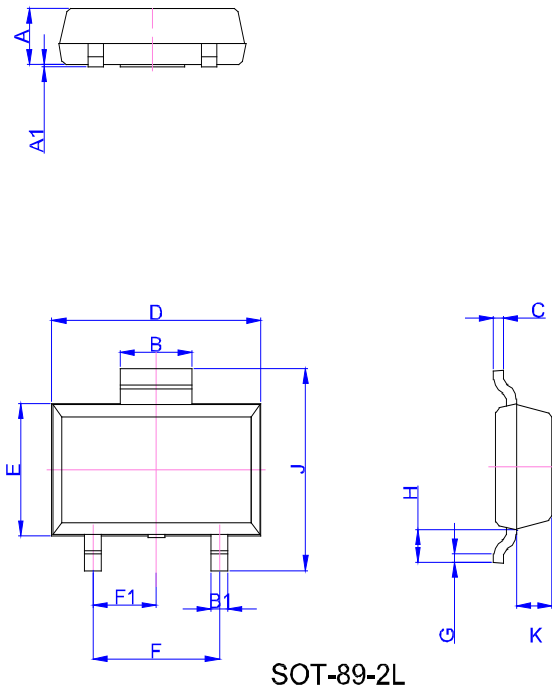

Ref.	Dimensions					
	Millimeters			Inches		
	Min.	Typ.	Max.	Min.	Typ.	Max.
A	1.3	1.4	1.5	0.051	0.055	0.059
A1	0.01	0.06	0.10	0.001	0.002	0.004
B	1.6	1.7	1.8	0.063	0.067	0.071
B1	0.3	0.4	0.5	0.012	0.016	0.020
C	0.22	0.254	0.32	0.009	0.010	0.013
D	4.75	4.95	5.15	0.187	0.195	0.203
E	2.90		3.30	0.114		0.130
F	2.80		3.20	0.110		0.126
F1	1.40		1.60	0.055		0.063
G	0.20	0.30	0.40	0.008	0.012	0.016
H	0.58	0.78	0.98	0.023	0.031	0.039
J	4.30	4.50	4.70	0.169	0.177	0.185
K	0.80		1.00	0.031		0.039

**FOOTPRINT-SOT-89-2L (dimensions in mm)**

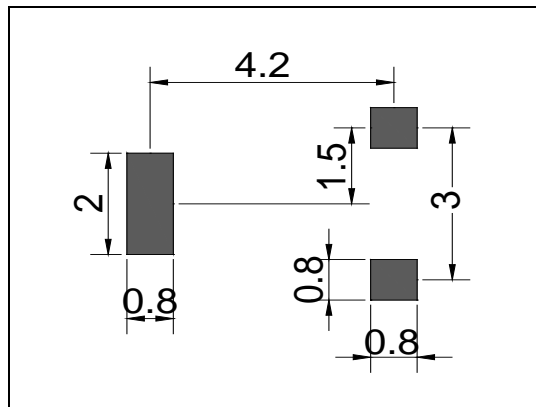



DELIVERY MODE

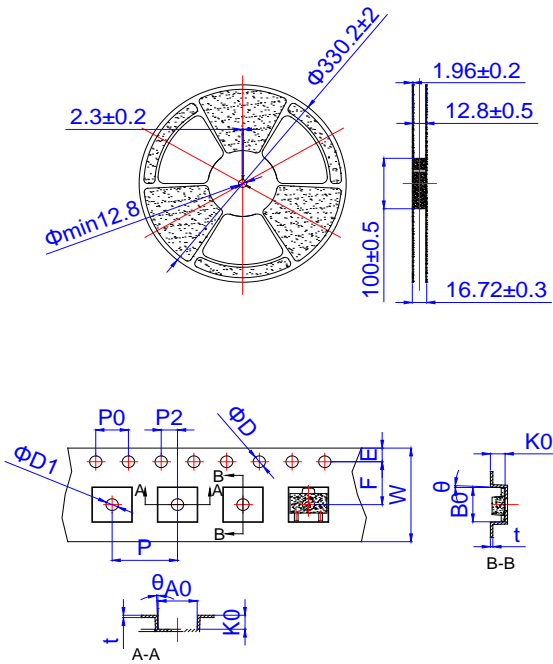

Ref.	Dimensions					
	Millimeters			Inches		
	Min.	Typ.	Max.	Min.	Typ.	Max.
E	1.65	1.75	1.85	0.065	0.069	0.073
F	5.45	5.50	5.55	0.215	0.217	0.219
P2	1.90	2.00	2.10	0.075	0.079	0.082
D	-	1.50	1.60	-	0.059	0.063
D1	1.50	-	-	0.059	-	-
P0	3.90	4.00	4.10	0.154	0.157	0.161
10P0	39.80	40.00	40.20	1.567	1.575	1.583
W	-	-	12.30	-	-	0.482
P	7.90	8.00	8.10	0.311	0.315	0.319
A0	5.20	5.30	5.40	0.204	0.208	0.212
B0	4.80	4.90	5.00	0.188	0.192	0.196
K0	1.75	1.85	1.95	0.069	0.073	0.076
t	0.20	0.25	0.30	0.008	0.010	0.012
$\theta$	3°		5°	3°		5°

PACKAGE	OUTLINE	REEL (PCS)	PER CARTON (PCS)	TAPE & REEL
SOT-89-2L	TAPING	4,000	40,000	13 inch

Information furnished in this document is believed to be accurate and reliable. However, Jiangsu JieJie Microelectronics Co., Ltd. assumes no responsibility for the consequences of use without consideration for such information nor use beyond it. Information mentioned in this document is subject to change without notice, apart from that when an agreement is signed, Jiangsu JieJie complies with the agreement. Products and information provided in this document have no infringement of patents. Jiangsu JieJie assumes no responsibility for any infringement of other rights of third parties which may result from the use of such products and information. This document supersedes and replaces all information previously supplied.

 is a registered trademark of Jiangsu JieJie Microelectronics Co., Ltd. Copyright ©2023 Jiangsu JieJie Microelectronics Co., Ltd. Printed All rights reserved.